

Item	Symbol	Indicator	Color	In
1	←	TURN-L	Green	+
2	ⓘ	HIGH-BEAM	Blue	+
3	⚡	CHARGE	Red	+
4				
A	→	TURN-R	Green	+
B	⚠	Warning	Red	+
C	🔋	BATTERY	Amber	+
D				+
		Back Light	Amber	

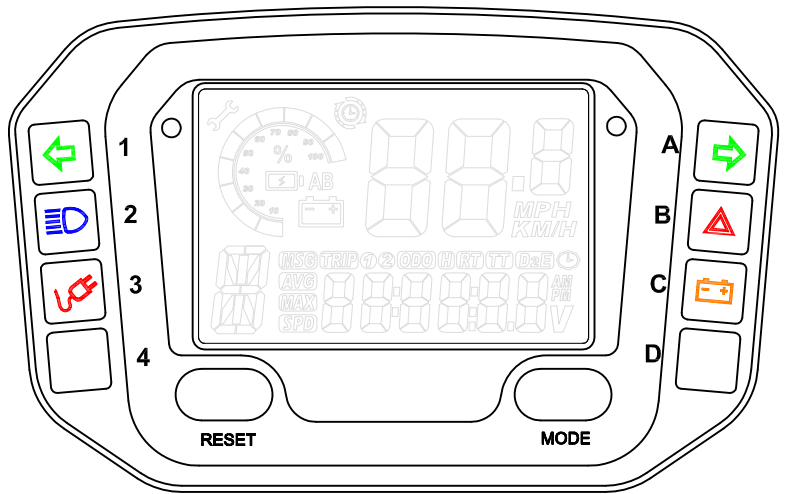

BAR	BAT_IN
1~10	On >55.0
1~9	On 54.3~54.9V
1~8	On 53.7~54.2V
1~7	On 53.1~53.6V
1~6	On 52.5~53.0V
1~5	On 51.9~52.4V
1~4	On 51.3~51.8V
1~3	On 50.7~51.2V
1~2	Flash 50.1~50.6V
1	Flash <=50.0V

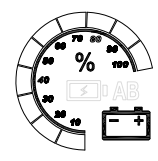

Function:

- Speed 0~100.0 km/H or 62 MPH
- ODO 0~99999.9 km or 62150.0 miles
- TRIP 0~999.9 km or 621.5 miles
- Adjustable km/H or MPH
- Battery Index With Bar
- \*\*6. Adjustable tyre circumference 1~3999mm (Default = 1610/mm)

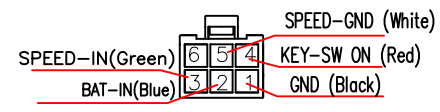
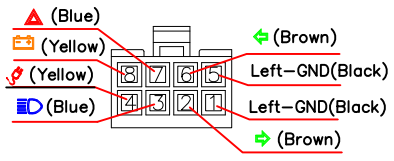
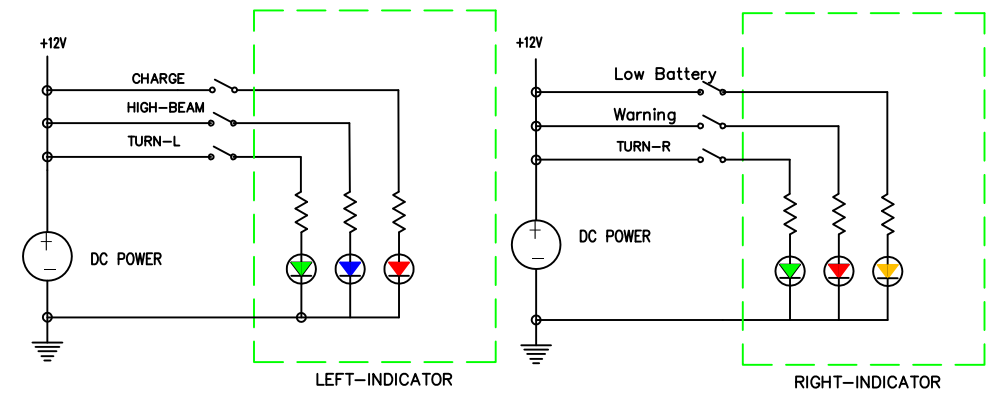
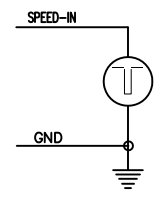
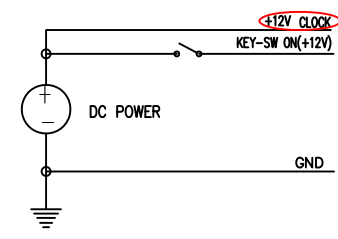
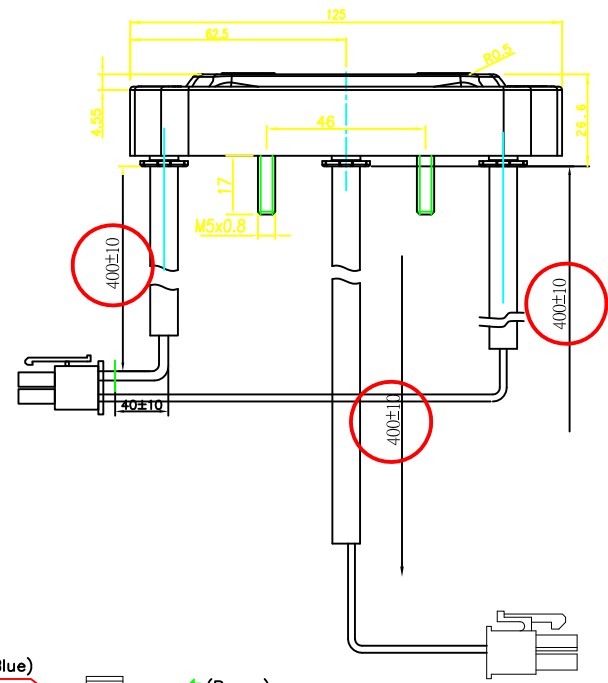

DWG JONES CHO	DATE	<b>PROPRIETARY</b> THIS TECHNICAL DATA IS PROPRIETARY TO STARS CO., LTD.	<b>STARS CO., LTD.</b> TAIWAN
CHECK SHIN WANG	DATE		
APPROVED JONES CHO	DATE		
TITLE <b>EV Display DS-9532-48</b>		DOCUMENT NO.	REV. 161210
FILE:		SHEET 1 OF 1	